



SR-LG Series Solar charge controller

User manual

Dear user :

Many thanks for you choosing our product!

Please read the user instructions carefully before usage.

Catalogue

1. Attention.....	3
2. Product introduction.....	3
3. Panel figure.....	4
4. Feature.....	4
5. Model.....	5
6. Installation and connection instruction.....	5
7. LCM indication and instruction.....	7
7.1Overall figure.....	7
7.2Display interface.....	8
7.3Mode operation and browse parameters.....	9
8. Controller status.....	10
9. System voltage alternative.....	10
10. System protection function description.....	10
10.1 Over temperature protection.....	10
10.2 Charge protection.....	11
10.3 Discharge protection.....	11
10.4 Short circuit protection.....	11
10.5 Over-load protection.....	11
10.6 Reverse connection protection.....	11
11. Operating mode.....	12
12. Error instruction and description.....	12
13. Parameters instruction.....	13
14. Accessories.....	14

1. Attention

Warning: This controller is a high power device, please read the instruction before use, take extra care when operating.

Safety notes:

- ⊙ read the instruction and attention carefully before use
- ⊙ Do not disassembly and repair the controller freely
- ⊙ Avoid direct sunlight and pay attention to ventilation When installation
- ⊙ Install appropriate fuse or circuit breaker on the outside of the controller
- ⊙ Disconnect the external fuse or circuit breaker when wiring
- ⊙ Be careful to prevent short-circuit when installing the battery
- ⊙ To ensure adopt the correct wire diameter, connect firmly, fasten the wire after connection
- ⊙ Temperature resistance should be fixed on the battery,the other end connect to the controller

2. *Product introduction*

This controller is designed for DC power supply system, small and medium-sized pv modules power system, using a dedicated computer chip to realize the intelligent control, all chips adopt industrial level, can be used in harsh environment. Meanwhile system offers specific indication for the charge, load , sorts of failure and various protections such as short circuit, over-load, over charge, particular anti-reversed polarity protection and so on, the controller used computer chip to sample the parameter of the battery voltage, photovoltaic cell voltage, discharge current and environment temperature. According to the battery's character, realized the accurate control to discharge rate, correction of the temperature compensation through special control model calculation.charging with the intelligent PWM dim way and charging compensation in accordance with the current temperature of the battery, compensation factor is $3\text{mv}/^{\circ}\text{C}/\text{unit}$.LCM could show all of the parameters and modes. Offer as many as five LED adjust way with lattice pattern to guarantee the battery works in the best status which could lengthen the service life of the battery. The controller has many work modes to satisfy different customer's request. Dial switch need to adjust if adopting different voltage system.

3. Panel figure

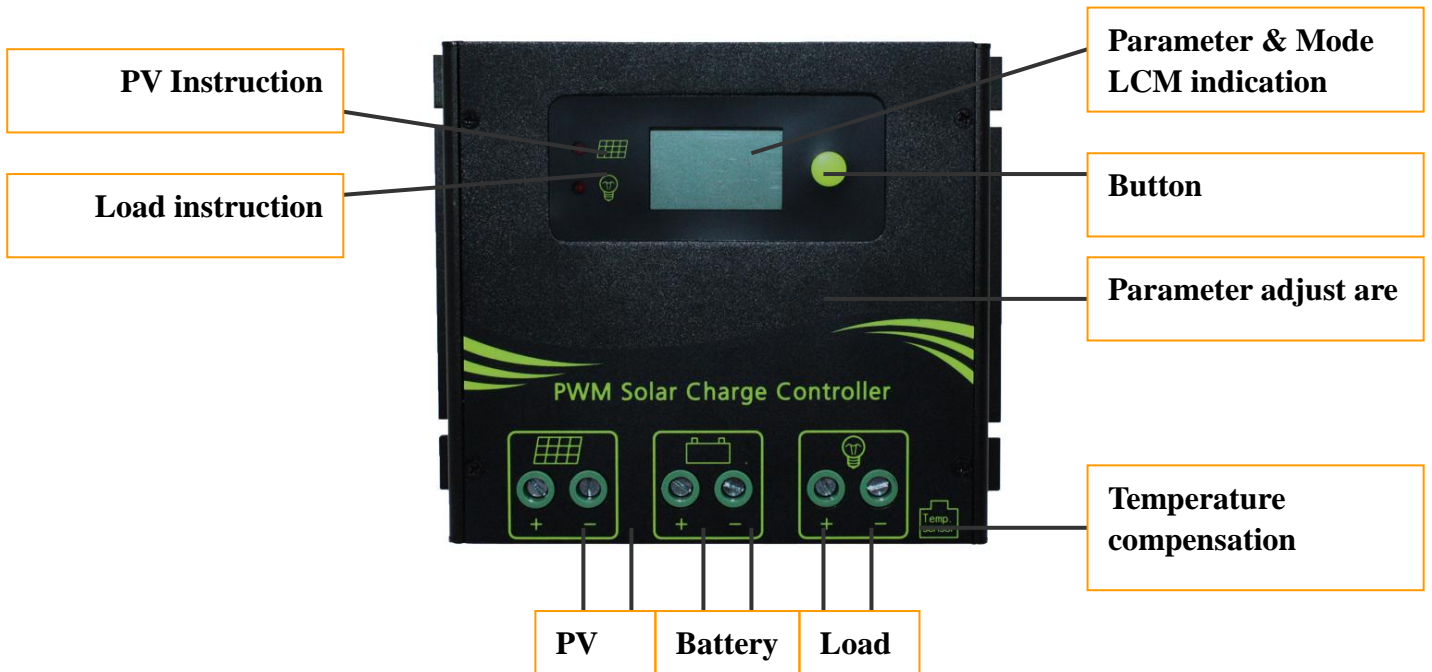

4. Feature

- 4.1、 The controller carried with LCM module which can display system status and parameters
- 4.2、 Begin to ascending charging automatically when the voltage of battery below the ascending charging recover voltage
- 4.3、 Temperature compensation become more accurate due to Double temperature sensors design,inner temperature sensor test the inner temperature of the controller, outer

temperature sensor test the outer temperature of the controller.

- 4.4、 The controller could figure out everyday's power of charge and discharge which make user assess the controller and entire system more easily
- 4.5、 With the charging current overload protection function, the controller will reduce the charge current to protect the charging circuit after it surpass the rated current.
- 4.6、 A equalizing charge every 30 days in order to prevent battery vulcanization
- 4.7、 Industrial-grade chips and precision components makes the controller can operate in any harsh environment
- 4.8、 Design of double MOS series control circuit and PWM dim control make the charging efficiency increased greatly
- 4.9、 The setting parameter possess the saving function which makes the parameter won't be erased after losing the electricity and system become more reliable.
- 4.10、 Three kinds of load work mode: purely light-operated, light-operated+time controlled, long-term on mode.

5. Model

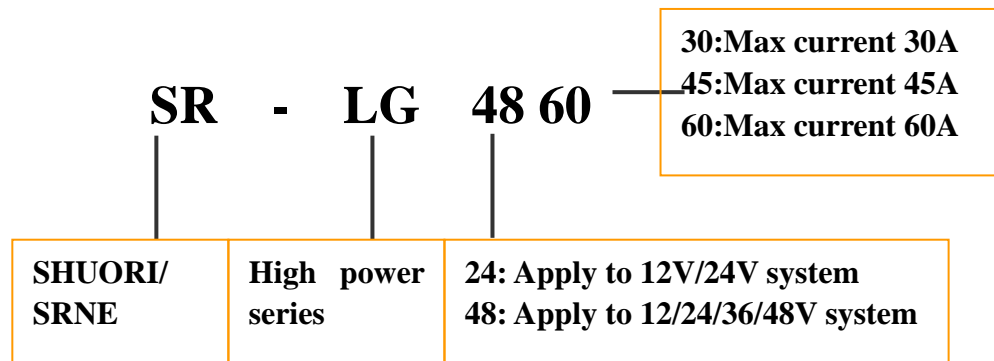

6. Installation and connection instruction

- 6.1、 Installation of controller must be reliable, size is as follows:
 - 6.1.1、 45A Boundary and Installation dimension

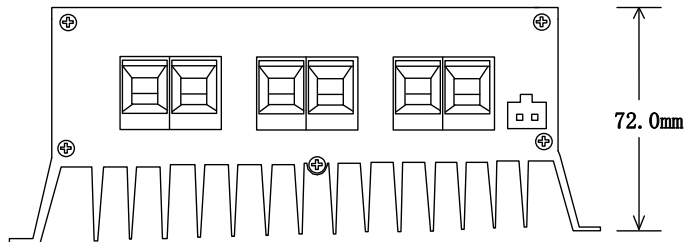
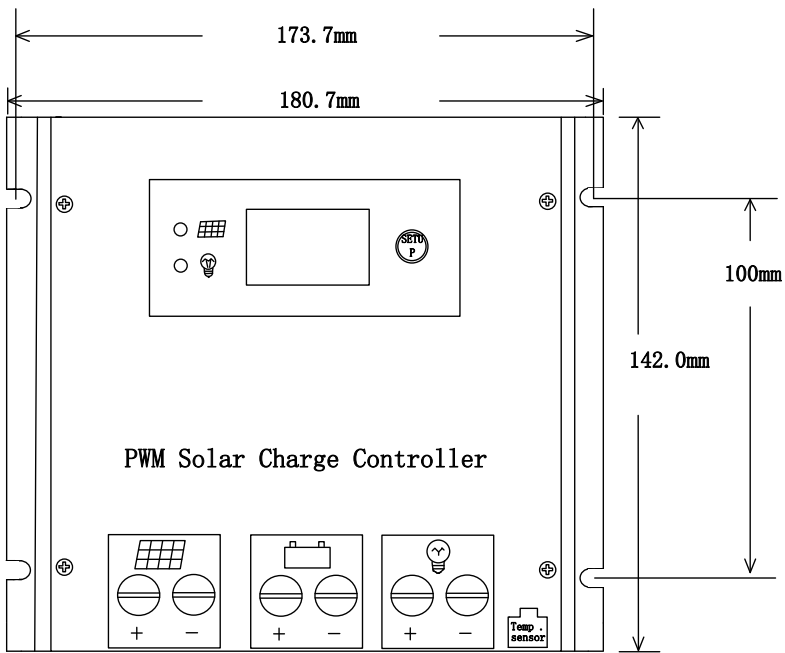

6.1.2、30A Boundary and Installation dimension

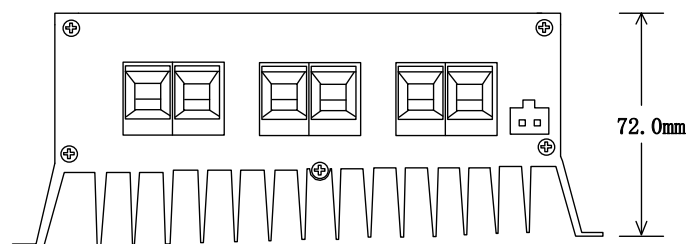
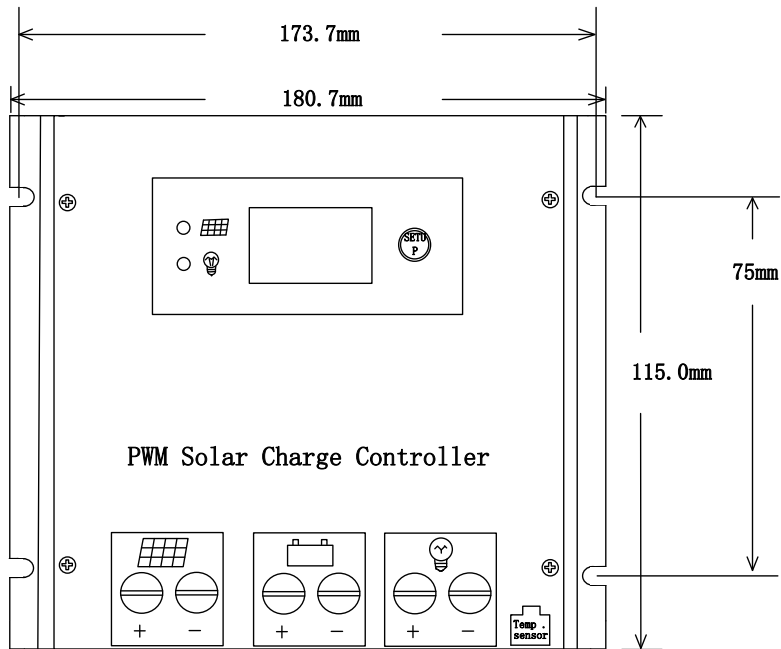

6.2、 Preparation of the wire:

Adopt the wire matching the current, plan the length of wire, strip 5mm insulation of one side of the controller's terminal and try to decrease the length of the connected wire so that a reduction in electrical loss.

6.3、 Battery connection

Pay attention to the pole + , - , do not connect reversely. If connect correctly, the controller will start to work or it's necessary to check the wire connection and battery's situation. Users could connect the system followed by the order showed in the below figure.

6.4、 Photovoltaic module connection

Pay attention to the pole + , - ,if sun light is tested, photovoltaic indicator will light on or it's necessary to check the connection.

6.5、 Load connection

Connect the load wire with the controller's output terminal, the current can't surpass the controller's rated current and pay attention to the + , - pole, for avoiding damage to the device ,do not connect reversely

6.6、 Temperature sensor connection

Connect one side of the temperature sensor to controller, the other side to the battery. There must be a good thermal contact with the battery shell.

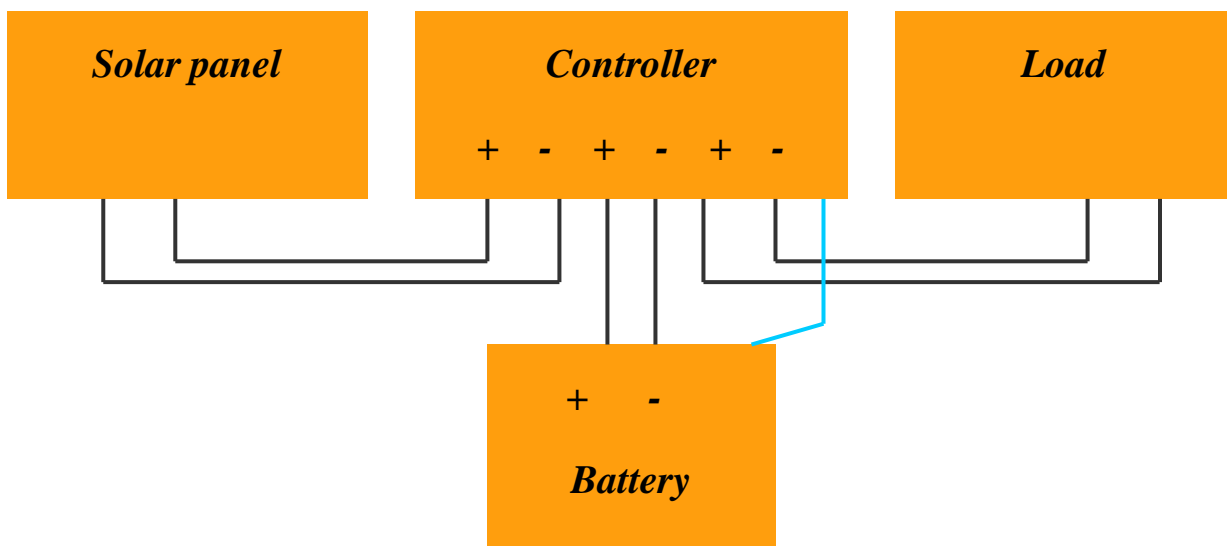

Attention : Connection according to the order showed in the upper figure

7. LCM indication instruction

The controller adopts segmentation LCM indicator which could show 7 items parameters

7.1、 Overall figure

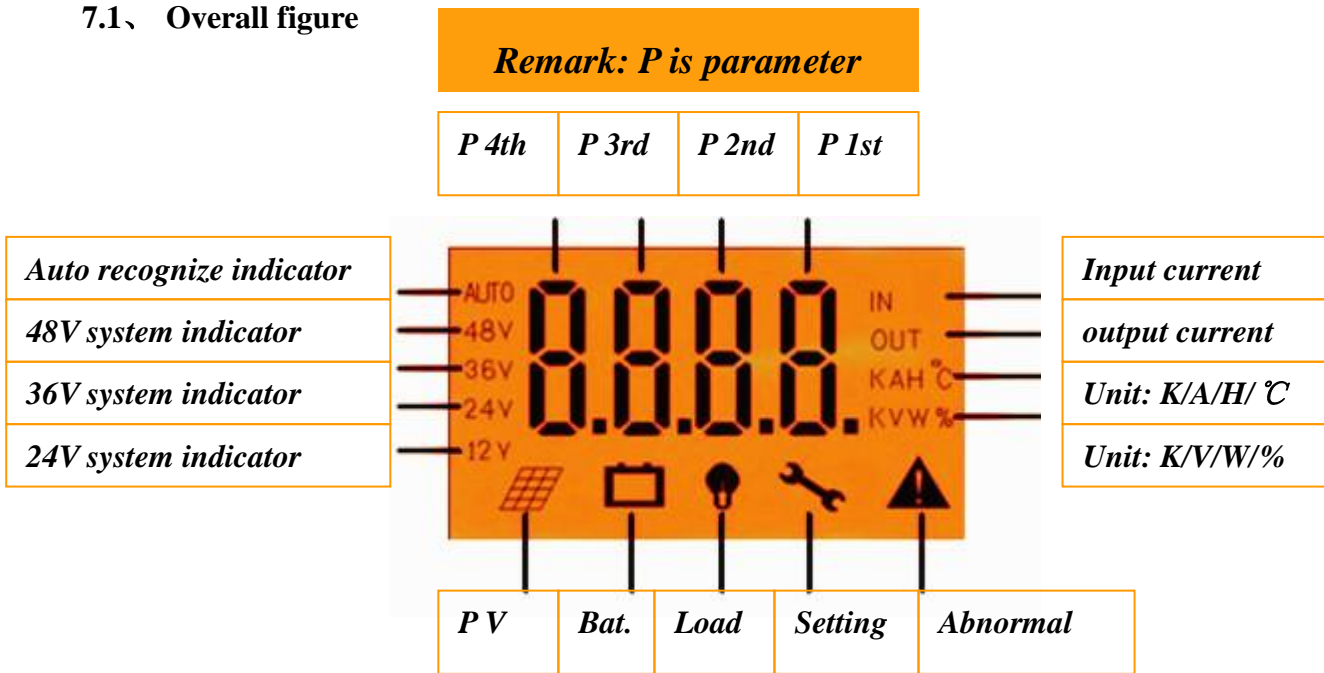

7.2、 Displayed page

Screen initialize firstly then show kinds of system's parameters when power on.

7.2.1、 Photovoltaic array current

This page shows the pv array real-time current

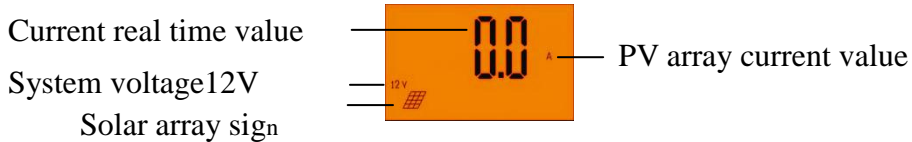

7.2.2、 Battery voltage

This page show the real-time battery voltage

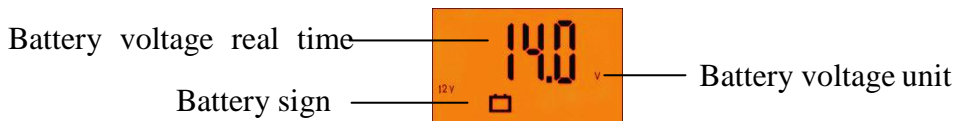

7.2.3、 Load current

This page show the real-time load current

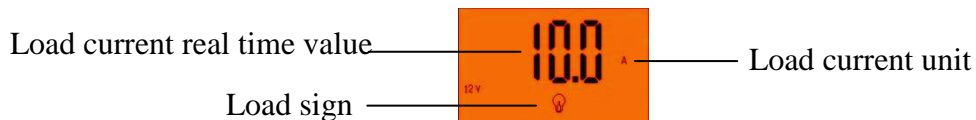

7.2.4、 Battery temperature

This page show the real-time controller's inner temperature

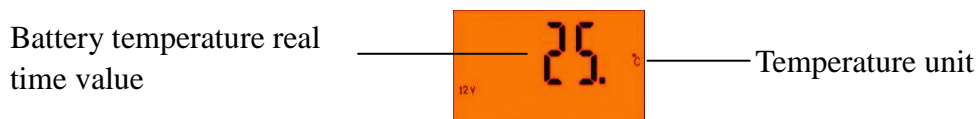

7.2.5、 Charge power on the day

This page show the real-time charge power on the day

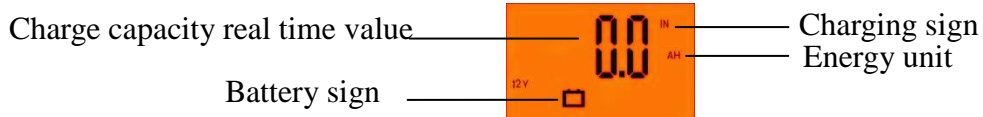

7.2.6、 Discharge power on the day

This page show the real-time discharge power on the day

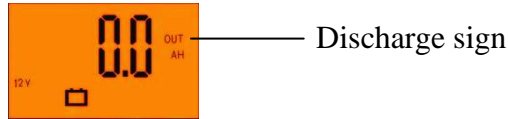

7.2.7、 Word mode

This page show the real-time work mode

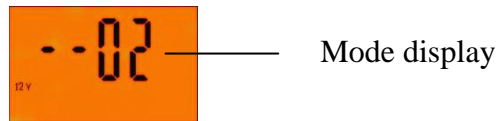

7.2.8、 Fault warning

This page show the corresponding error code when system abnormal occurs, return to normal display after cancel the error

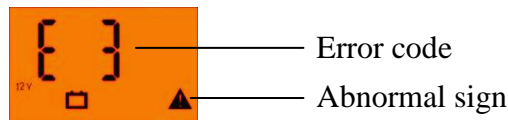

7.3、 Mode operation and parameter browse

7.3.1、 Parameter preview

Click the button: switch to next display page

Long press the button: long press the button in non-work mode page start the auto LCM switch display.

7.3.2、 Working mode setting

Positioning the work mode page according to the “parameter preview”

Long press button: long-press in work page,click to user’s required mode after the number blink,long-press for a period of time to exit with saving the parameter automatically,LCM switch to display again automatically after exit.

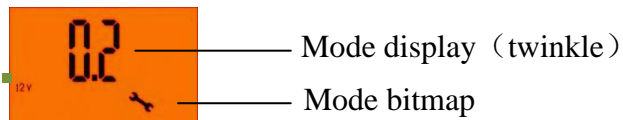

ATTENTION: switch automatically—It’s not necessary to participate for users,LCM will switch to next page automatically every 3s.

8. Controller status

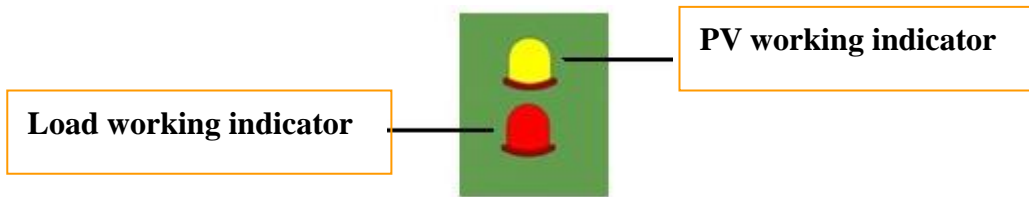

State Led Light	Always off	Always on	twinkle Slow	twinkle fast
PV array instruction	Night	Daytime	In charging	System over voltage
Load instruction	Load off	Load on	Overload	Short circuit

9. System voltage alternative

Before setting, please kindly check the system voltage. This controller support 12/24/36/48V system. Please choose the voltage before use.

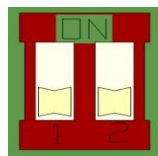

Truth Table		
System	Position	
12U	↓	↓
24U	↓	↑
36U	↑	↓
48U	↑	↑

System voltage	Dial switch state	Description
12v	Down Down	The right and left gear both turn to Downward.
24V	Down Up	Turn the left gear to Downward, Turn the right gear to Upward. .
36V	Up Down	Turn the left gear to Upward, Turn the right gear to Downward
48V	Up Up	The right and left gear both turn to Upward.

Please setting firstly before running the system.

10. System protection function description

10.1、Over temperature protection

Controller temperature exceed 90°C will close the load and charging efficiency will decrease.

Temperature less than 85°C will recover.

Battery temperature exceed 55°C will close the load and charging will closed. Temperature less than 55°C will recover.

10.2、 Charging protection

Decrease the charging efficiency when PV array charging current more than 60A and less then 1.25 times of 60A for 60s.

Decrease the charging efficiency when PV array charging current more than 1.25 and less then 1.5 times of 60A for 5s.

Decrease the charging efficiency when PV array charging current more than 1.5 times of 60A for 1s.

PV array indicator will close.

Recover after decrease charging efficiency for 1min.

10.3、 Over discharge protection

The controller will start the over discharge protection and close the load when the battery voltage is less than over discharge voltage and duration 5s.

The controller will start the over discharge recovery protection when the battery voltage exceed the over discharge recovery voltage.The next night will remove automatically.

10.4、 Short circuit protection

Short circuit:

The first time short circuit in one day will recover after 5s later.

The second time will recover after 10s later.

The third time will recover after 15s later.

The forth time will recover after 20s later.

The fifth time or more than five times will recover after 4hours later.

Also can recover by long press the key!

10.5、 Over load protection

Over-load protection:

Close the load when load current more than 1 also less than 1.25 times of 60A for 60 seconds;

Close the load when load current more than 1.25 also less than 1.5 times of 60A for30 seconds;

Close the load when load current more than 1.5 also less than 3 times of 60A for 5 seconds;

LED load indicator twinkle slow.

Recovery normal after overload stop 60s later, not have the limited times.

10.6、 Reverse connection protection

This controller including the PV array, battery and load reverse connection protection.

11. Operating mode

LED Display	Mode	LED Display	Mode
00	Purely light-operated	08	Light-operated + time-controlled for 8 hours
01	Light-operated + time-controlled for 1 hour	09	Light-operated + time-controlled for 9 hours
02	Light-operated + time-controlled for 2 hours	10	Light-operated + time-controlled for 10 hours
03	Light-operated + time-controlled for 3 hours	11	Light-operated + time-controlled for 11 hours
04	Light-operated + time-controlled for 4 hours	12	Light-operated + time-controlled for 12 hours
05	Light-operated + time-controlled for 5 hours	13	Light-operated + time-controlled for 13 hour
06	Light-operated + time-controlled for 6 hours	14	Light-operated + time-controlled for 14 hours
07	Light-operated + time-controlled for 7 hours	15	Always on mode

12. Error instruction and description

If have any short circuit state, the LCM will show the corresponding error instruction. Please kindly check the error code and description as below.

Error code	Fault description	Solutions and recovery condition	LCM display	Led display
E1	Too high of controller temperature	Please ensure the solar panel and load power not exceeded the rate power then place the controller to ventilation environment. Auto recover after temperature decrease. Controller will decrease the charging efficiency and close discharge.	Bat and PV twinkle at the same time	--
E2	Battery over	Please check right connection and	Bat	Solar panel

	voltage	voltage of the battery	twinkle	indicator twinkle fast
E3	Battery over discharge	Ensure the input voltage of the battery is normal. Recover auto after full charge	Bat twinkle	--
E4	Excessive charging current	Please check the solar panel power whether exceed the controller's rate power	Pv twinkle	--
E7	Load short circuit	Ensure the output line of the load not have short circuit. After eliminate the faults then long press the key or hold on it will recover automatically.	Load twinkle	Load indicator twinkle fast
E8	Overload	Please check the load power whether exceed the controller's rate power. After decrease the load then long press the key or hold on it will recover automatically.	Load twinkle	Load indicator twinkle slow
E9	Battery overheat	Please check the battery temperature overheat or not. Place the controller to ventilation environment. Controller will close charging and auto recover after temperature decrease.	Bat twinkle	Solar panel indicator twinkle fast

13. Parameters instruction

Parameter	Value
System voltage	12V/24V/36V/48V
Rate charging current	45A/30A
Rate load current	45A/30A
No load loss	<12mA
Charging circuit voltage drop	Less or equal to 0.5V
Discharge circuit voltage drop	Less or equal to 0.5V
Solar input voltage	<140V

Re-entrant boost charge mode voltage	13.2V ×2/24V; ×3/36V; ×4/48V
Over voltage protection	17.0V ×2/24V; ×3/36V; ×4/48V
limited voltage for charging	15.5V ×2/24V; ×3/36V; ×4/48V
Equal charging voltage	Boost charge voltage +0.5V
Equal charging interval	30days
Direct charge voltage	14.4V ×2/24V; ×3/36V; ×4/48V
Float charge voltage	13.6V ×2/24V; ×3/36V; ×4/48V
Over discharge voltage	11.0V ×2/24V; ×3/36V; ×4/48V
Over discharge recover voltage	12.5V ×2/24V; ×3/36V; ×4/48V
Equal charging time	1H
Boost voltage charging time	2H
Temperature compensation	-3.0mv/°C/2V
Light-control voltage	5V ×2/24V; ×3/36V; ×4/48V
Light control delay	10min
Controller over-temperature protection	>90°C
Battery over-temperature protection	>55°C
Working temperature	-35°C to +85°C
Control method	Charging: PWM
Time of lcd back- light auto shut down	30 (s)
Data auto transfer time	3 (s)
Time of Led lattice closed	25 (s)
Weight	1.08Kg/45A 0.9Kg/30A

15. Accessories

Temperature probe	1pcs
Screwdriver.	1pcs